

TRBA and TFBA



TRBA Rounded Roof Edge
Here shown with side panel

TFBA Straight Roof Edge
Here shown with side panel

Metal Color Choices

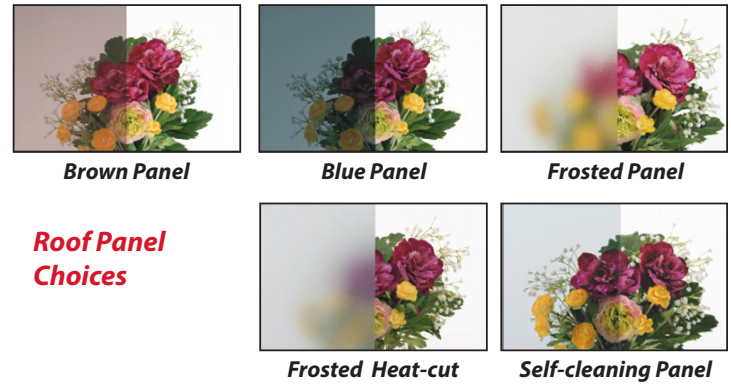

Roof Panel Choices

BEST!

Available Projections:
2.47' / 3.13' / 4.11'
Available Length:
3.4' to Endless

| | Brown Panel | Blue Panel | Frosted Panel | Frosted HC | Self-cleaning |
|-----------------------|-------------|------------|---------------|------------|---------------|
| Heat-cut Ratio | 45% | 40% | 16% | 70% | 15% |
| Visible Light | 34% | 20% | 88% | 76% | 87% |
| UV-Ray Cut | 100% | 100% | 100% | 100% | 100% |



メニーウェルA (600タイプ)



1階設置

UC/サイズ9030S/FB型/柱なし式

メニーウェルA (600タイプ)



2階設置

屋根側面パネル

屋根側面パネルの取り付けが可能です。

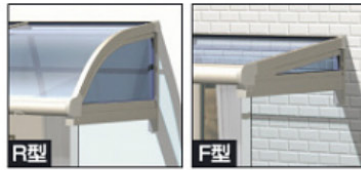

R型

F型

Support braces every 3 panels



Support brace-locations are flexible

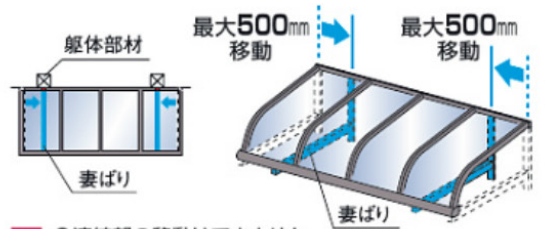

- 連結部の移動はできません。
- 妻ばりを移動した場合、屋根側面パネルの取り付けはできません。



Straight Edge Style

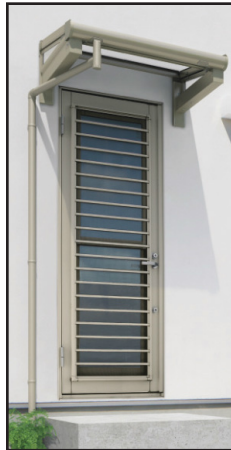

Rounded Edge Style



Japanese Aluminum AWNINGS

Measurements in millimeters



Straight Edge Style

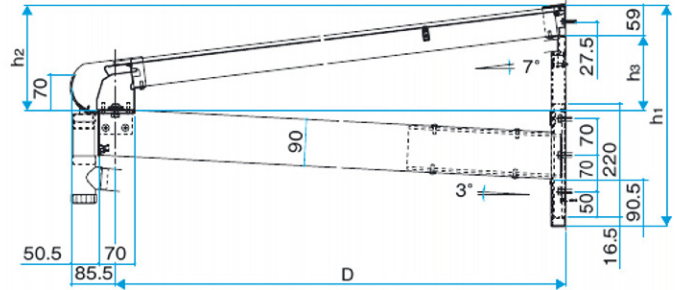

●TFBA型 (出幅2~4尺)

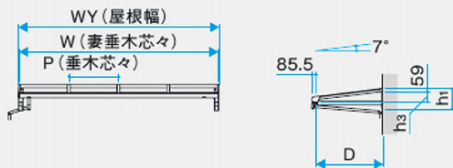

●TFBB型 (出幅2~4尺)

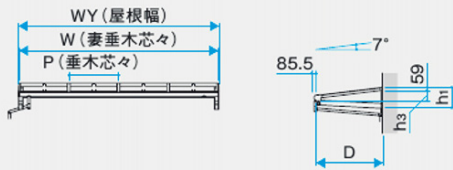

■間口 (W・WY)、垂木 (P)

(単位: mm)

| 呼称間口 | W | WY | 垂木P | |
|-------------|-------|-------|--------|---------|
| | | | 600タイプ | 1500タイプ |
| 0.5間 (30) | 909 | 936 | 909 | 454.5 |
| 1.0間 (60) | 1818 | 1845 | | |
| 1.5間 (90) | 2727 | 2754 | | |
| 2.0間 (12) | 3636 | 3663 | | |
| 2.5間 (15) | 4545 | 4572 | | |
| 3.0間 (18) | 5454 | 5481 | | |
| 3.5間 (21) | 6363 | 6390 | | |
| 4.0間 (24) | 7272 | 7299 | | |
| 4.5間 (27) | 8181 | 8208 | | |
| 5.0間 (30) | 9090 | 9117 | | |
| 0.5間 (100) | 1000 | 1027 | 1000 | 500 |
| 1.0間 (200) | 2000 | 2027 | | |
| 1.5間 (300) | 3000 | 3027 | | |
| 2.0間 (400) | 4000 | 4027 | | |
| 2.5間 (500) | 5000 | 5027 | | |
| 3.0間 (600) | 6000 | 6027 | | |
| 3.5間 (700) | 7000 | 7027 | | |
| 4.0間 (800) | 8000 | 8027 | | |
| 4.5間 (900) | 9000 | 9027 | | |
| 5.0間 (1000) | 10000 | 10027 | | |

■ (600タイプ) 出幅 (D)、高さ (h1・h2・h3)

(単位: mm)

| 呼称出幅 | D | h1 | h2 | h3 |
|---------|------|-----|---------|-----|
| 2尺 (20) | 670 | 391 | 連結部:411 | 178 |
| 3尺 (30) | 870 | 426 | 連結部:446 | 203 |
| 4尺 (40) | 1170 | 478 | 連結部:498 | 240 |

●正面図<600タイプ>

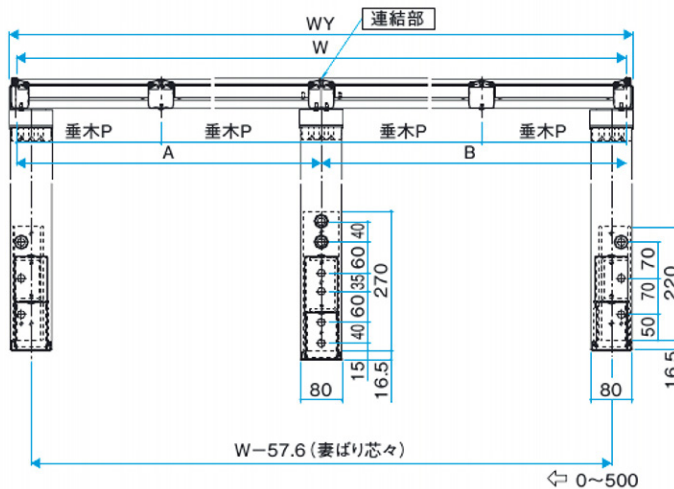

●側面図<1500タイプ>

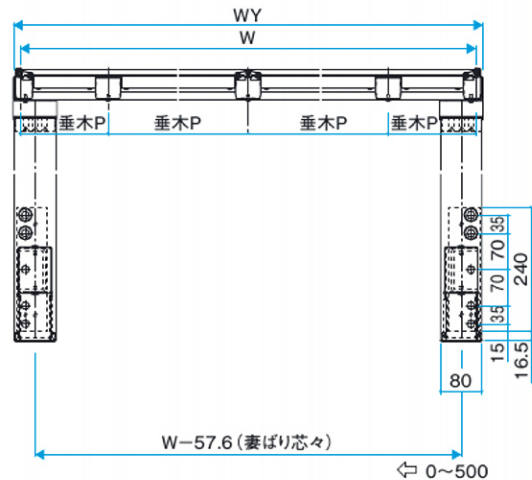

Rounded Edge Style

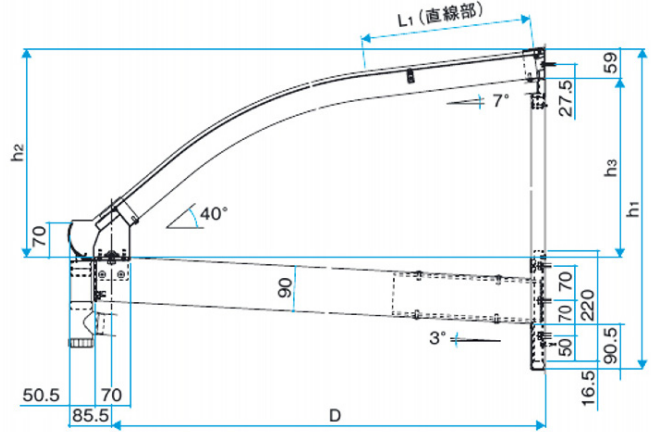

●TRBA型 (出幅2~4尺)

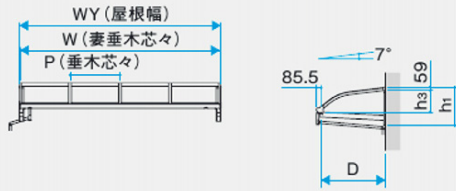

●TRBB型 (出幅2~4尺)

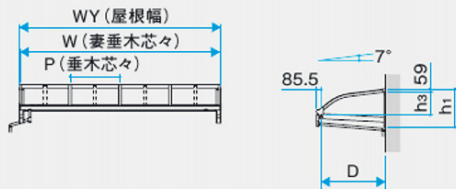

■間口 (W・WY)、垂木 (P)

(単位: mm)

| 呼称間口 | W | WY | 垂木P | | |
|-----------|-------------|-------|--------|---------|-------|
| | | | 600タイプ | 1500タイプ | |
| 関東間 | 0.5間 (30) | 909 | 936 | 909 | 454.5 |
| | 1.0間 (60) | 1818 | 1845 | | |
| | 1.5間 (90) | 2727 | 2754 | | |
| | 2.0間 (12) | 3636 | 3663 | | |
| | 2.5間 (15) | 4545 | 4572 | | |
| | 3.0間 (18) | 5454 | 5481 | | |
| | 3.5間 (21) | 6363 | 6390 | | |
| | 4.0間 (24) | 7272 | 7299 | | |
| | 4.5間 (27) | 8181 | 8208 | | |
| | 5.0間 (30) | 9090 | 9117 | | |
| メーターモジュール | 0.5間 (100) | 1000 | 1027 | 1000 | 500 |
| | 1.0間 (200) | 2000 | 2027 | | |
| | 1.5間 (300) | 3000 | 3027 | | |
| | 2.0間 (400) | 4000 | 4027 | | |
| | 2.5間 (500) | 5000 | 5027 | | |
| | 3.0間 (600) | 6000 | 6027 | | |
| | 3.5間 (700) | 7000 | 7027 | | |
| | 4.0間 (800) | 8000 | 8027 | | |
| | 4.5間 (900) | 9000 | 9027 | | |
| | 5.0間 (1000) | 10000 | 10027 | | |

■(600タイプ) 出幅 (D)、直線部 (L₁)、高さ (h₁・h₂・h₃)

| 呼称出幅 | D | L ₁ | h ₁ | h ₂ | h ₃ | |
|---------|------|----------------|----------------|----------------|----------------|-------|
| 2尺 (20) | 670 | 139 | 606 | 連結部:626 | 393.5 | 334.5 |
| 3尺 (30) | 870 | 340.5 | 641 | 連結部:661 | 418 | 359 |
| 4尺 (40) | 1170 | 643 | 694 | 連結部:713.5 | 455 | 396 |

●正面図<600タイプ>

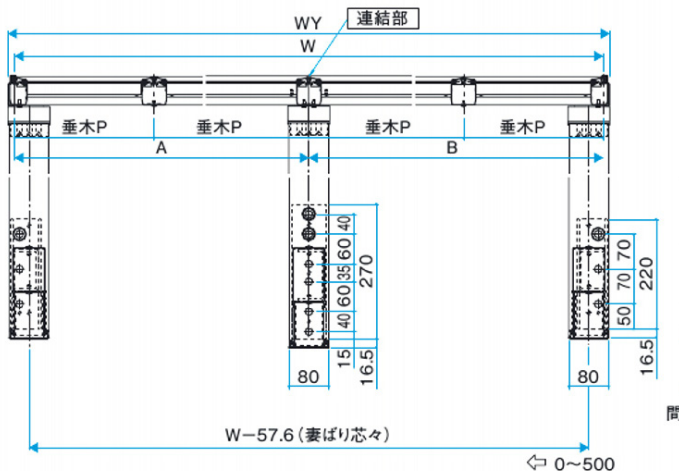

●側面図<1500タイプ>

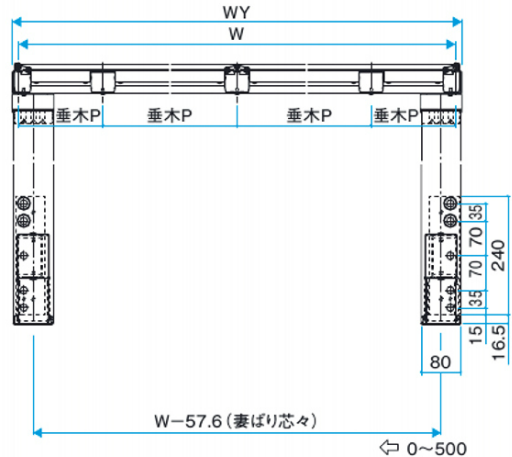

Measurements in millimeters